

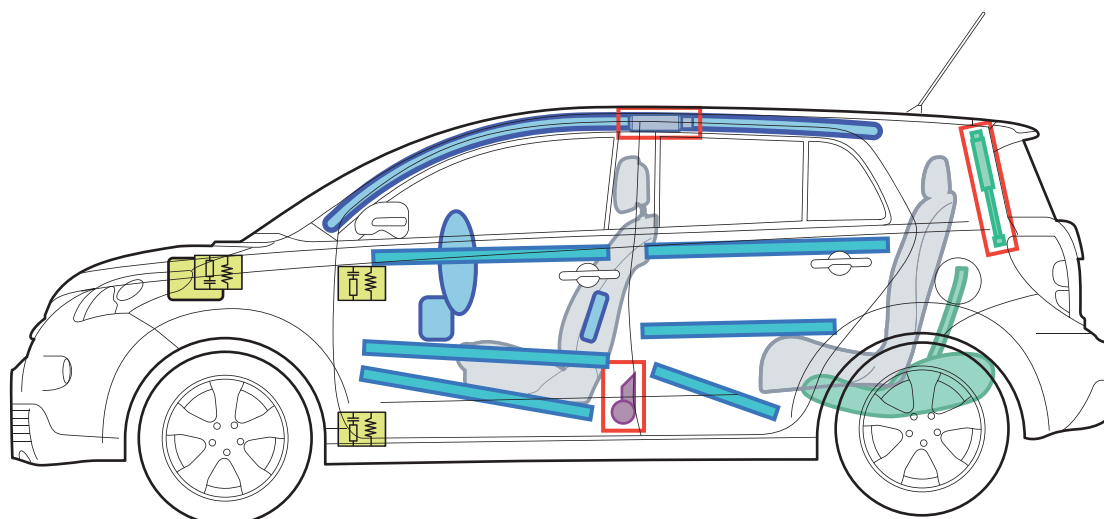

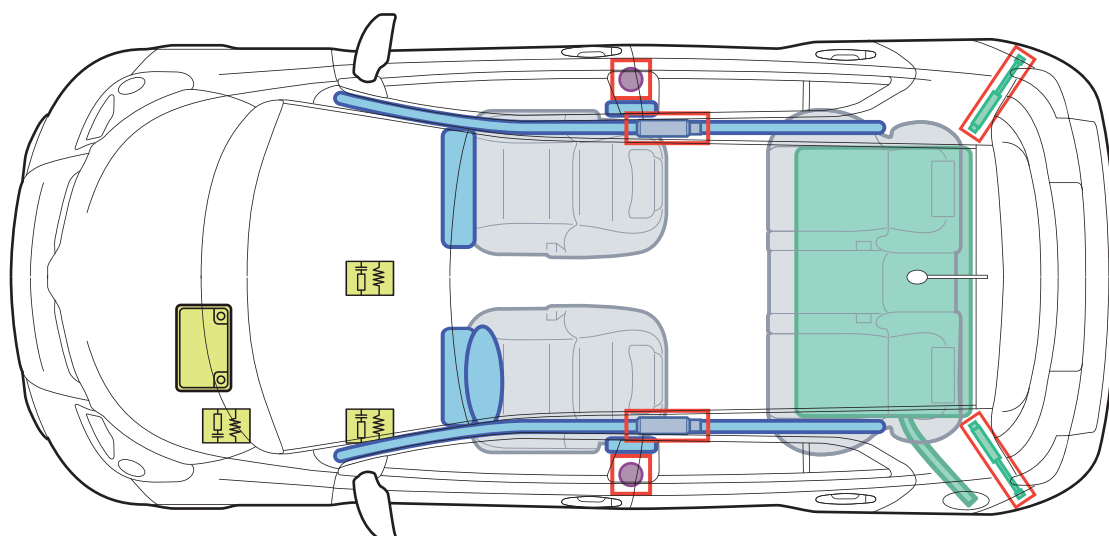





# Toyota Urban Cruiser

(XP11(a), od 01/2009)



## Legenda

	Poduszka powietrzna		Wzmocnienie konstrukcji nadwozia		Moduł sterujący
	Generator gazowy		Amortyzator gazowy		Akumulator
	Napinacz pasów bezpieczeństwa		Zbiornik paliwa		

A